

Skaning laserowy

autor: Piotr Kuczma

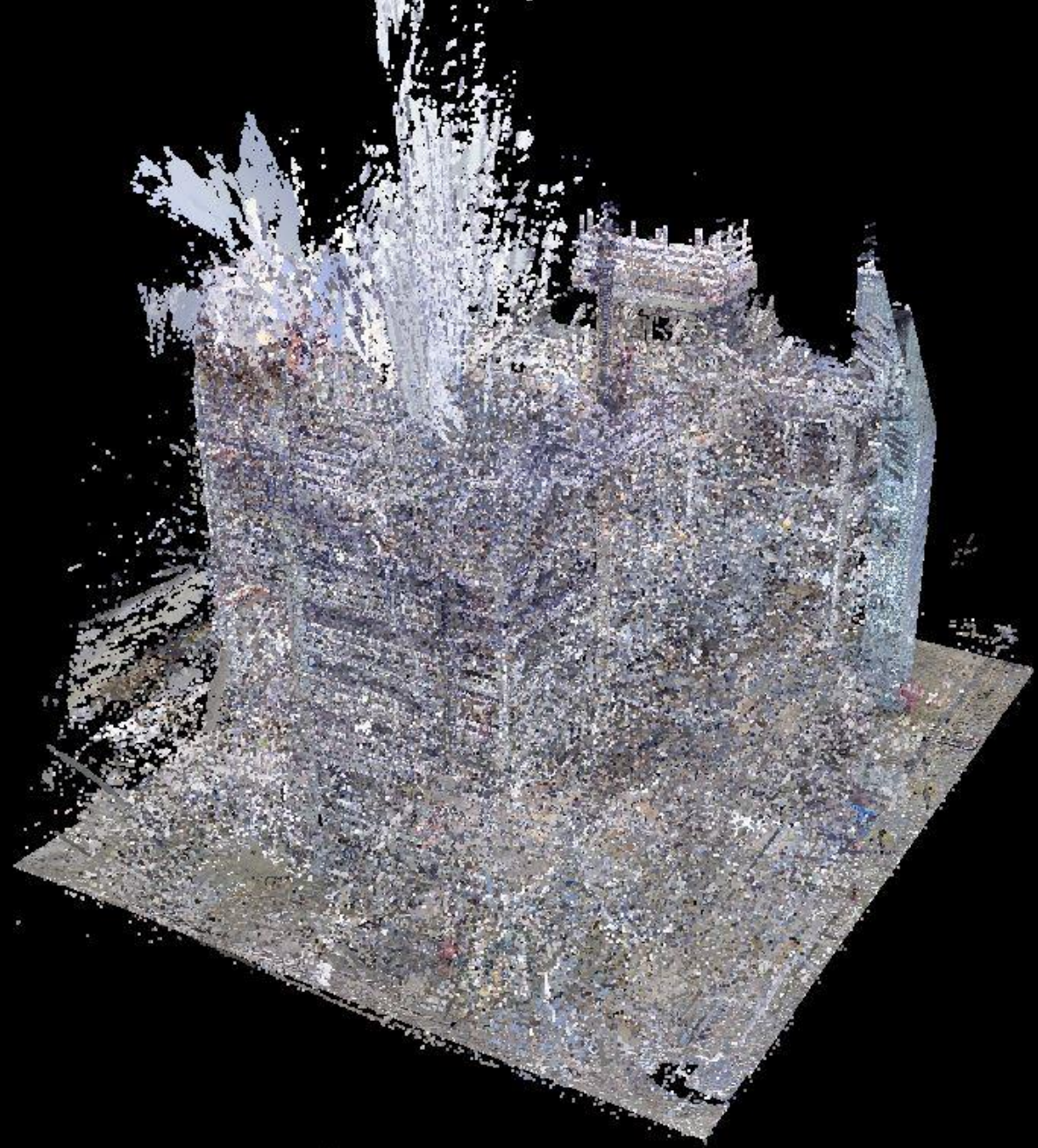

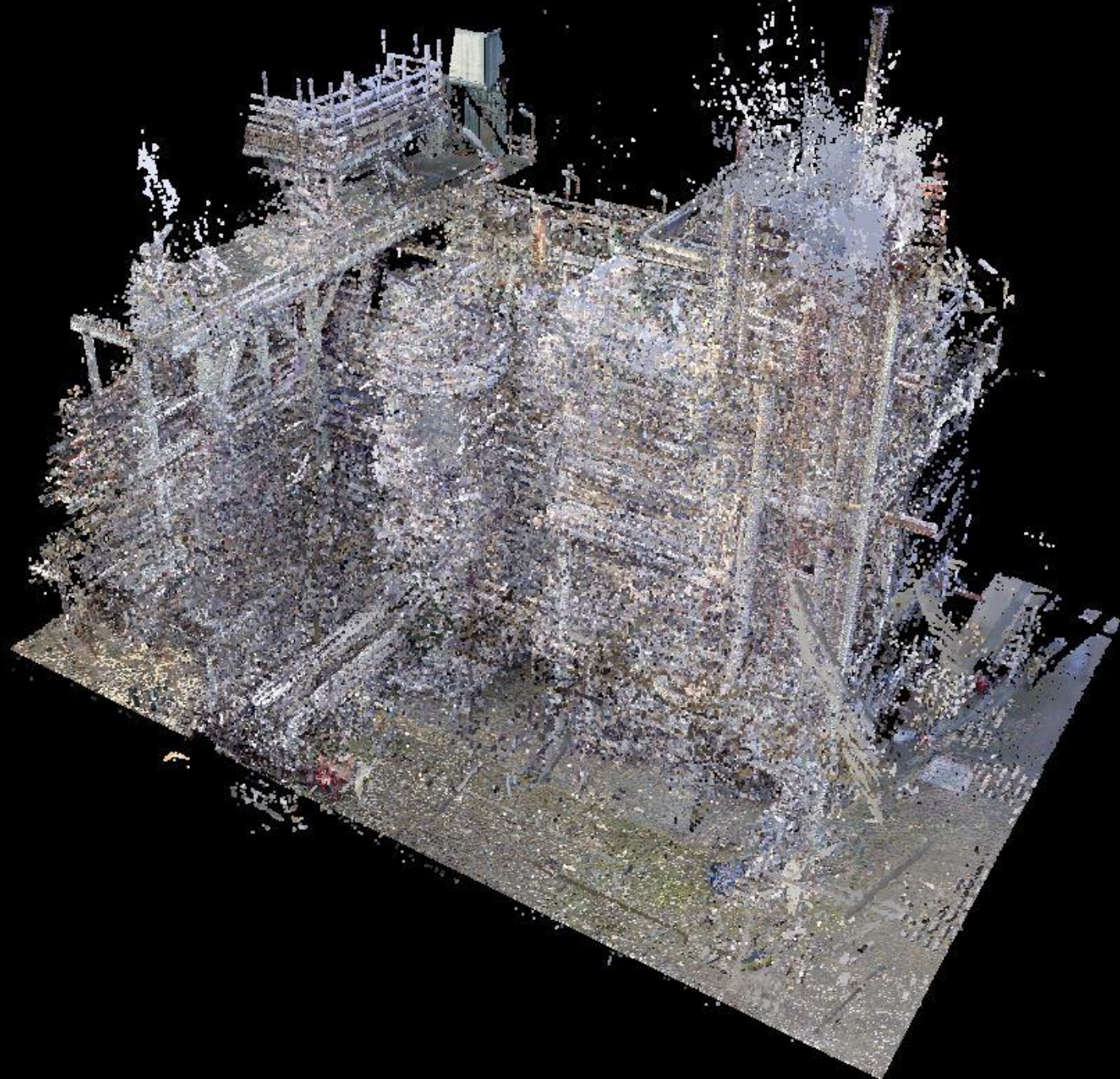







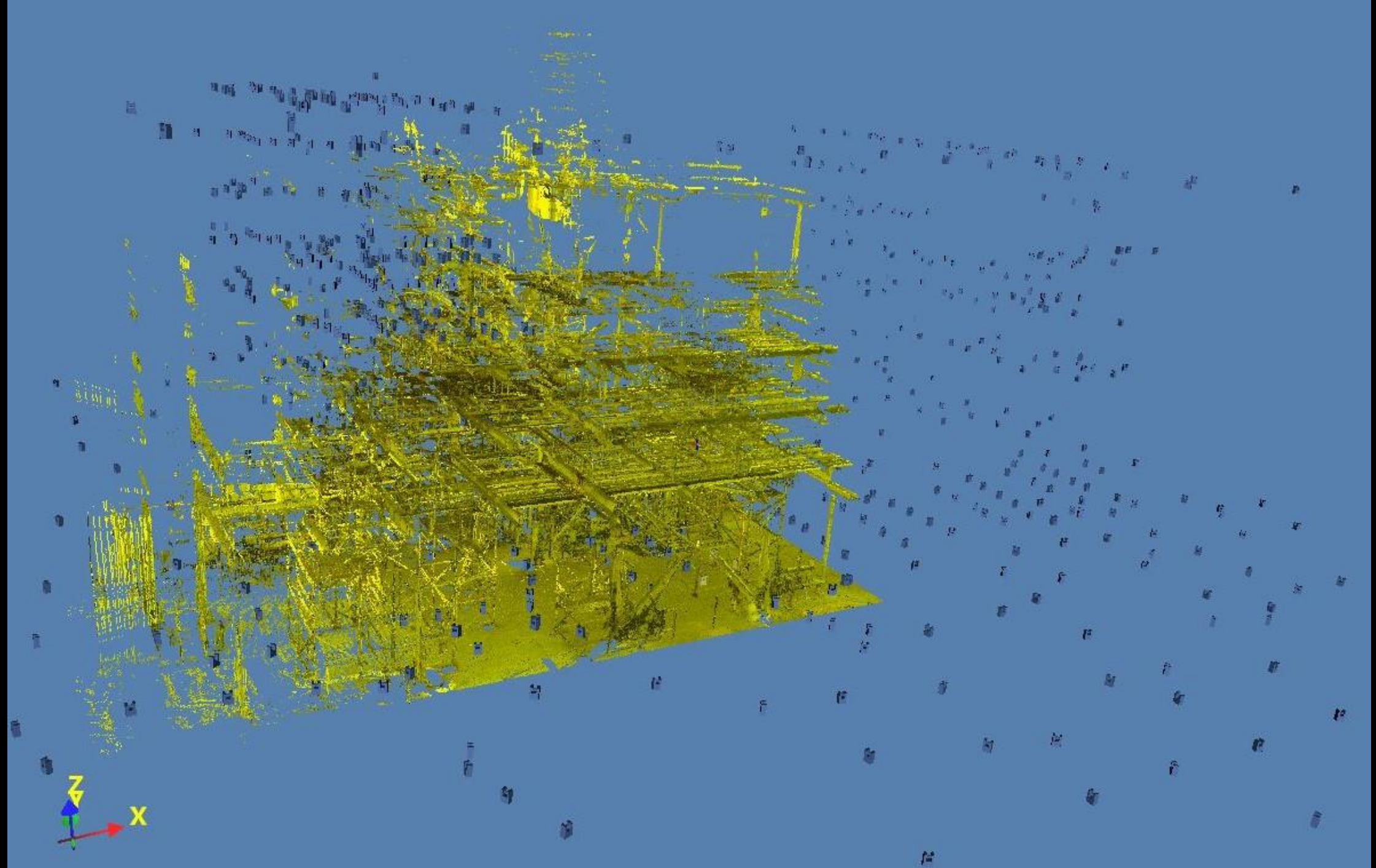

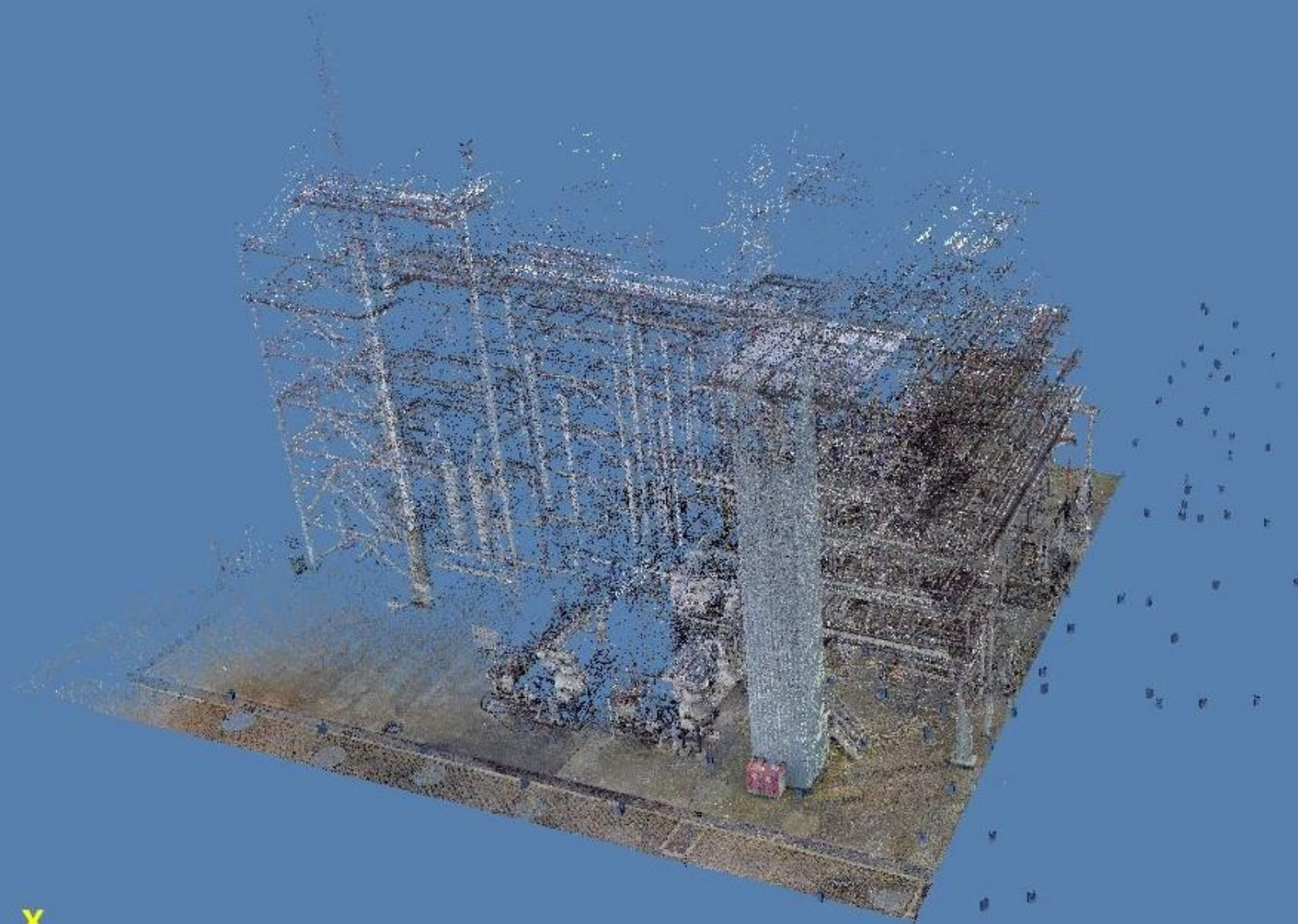
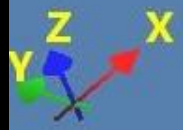

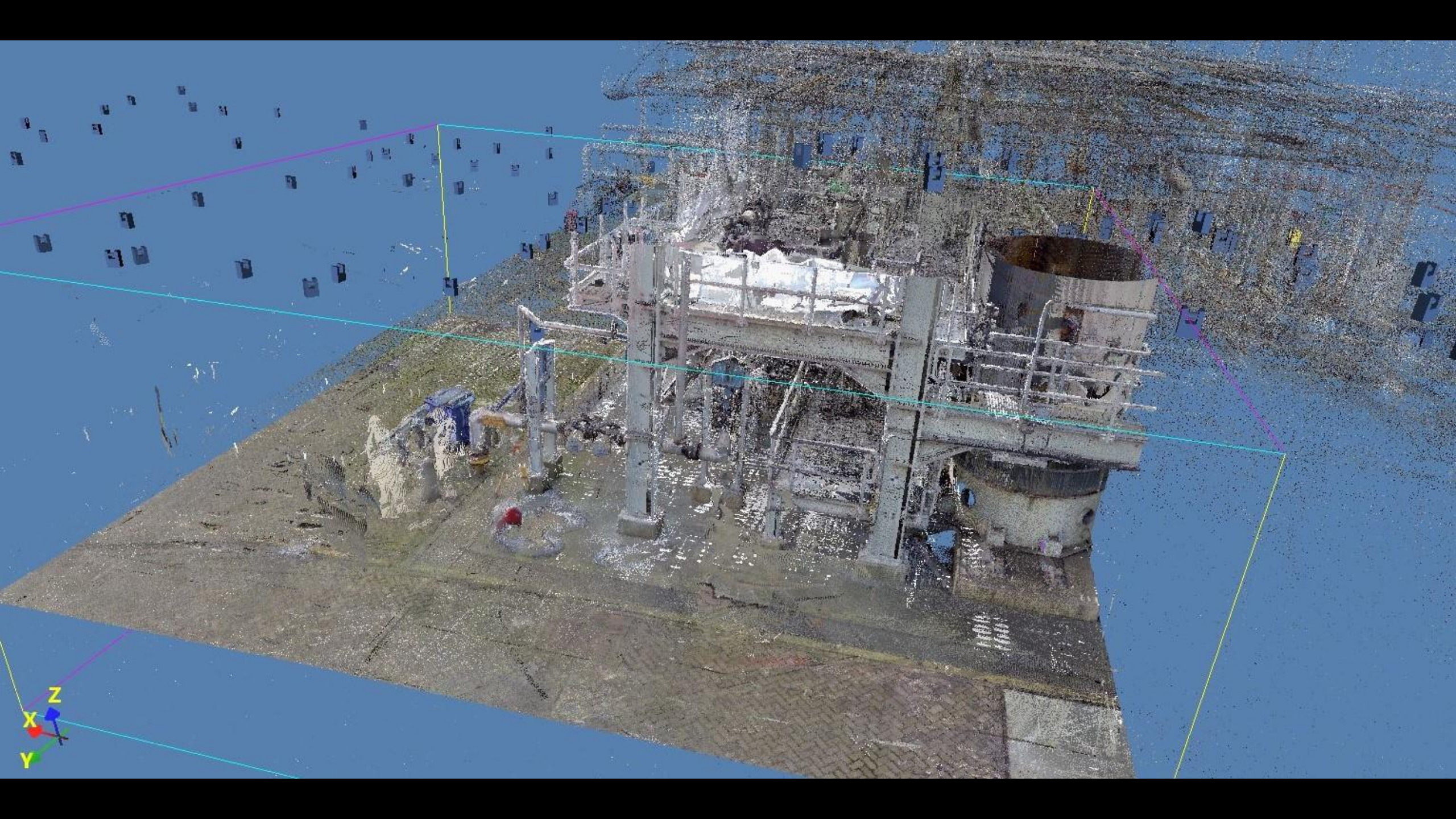



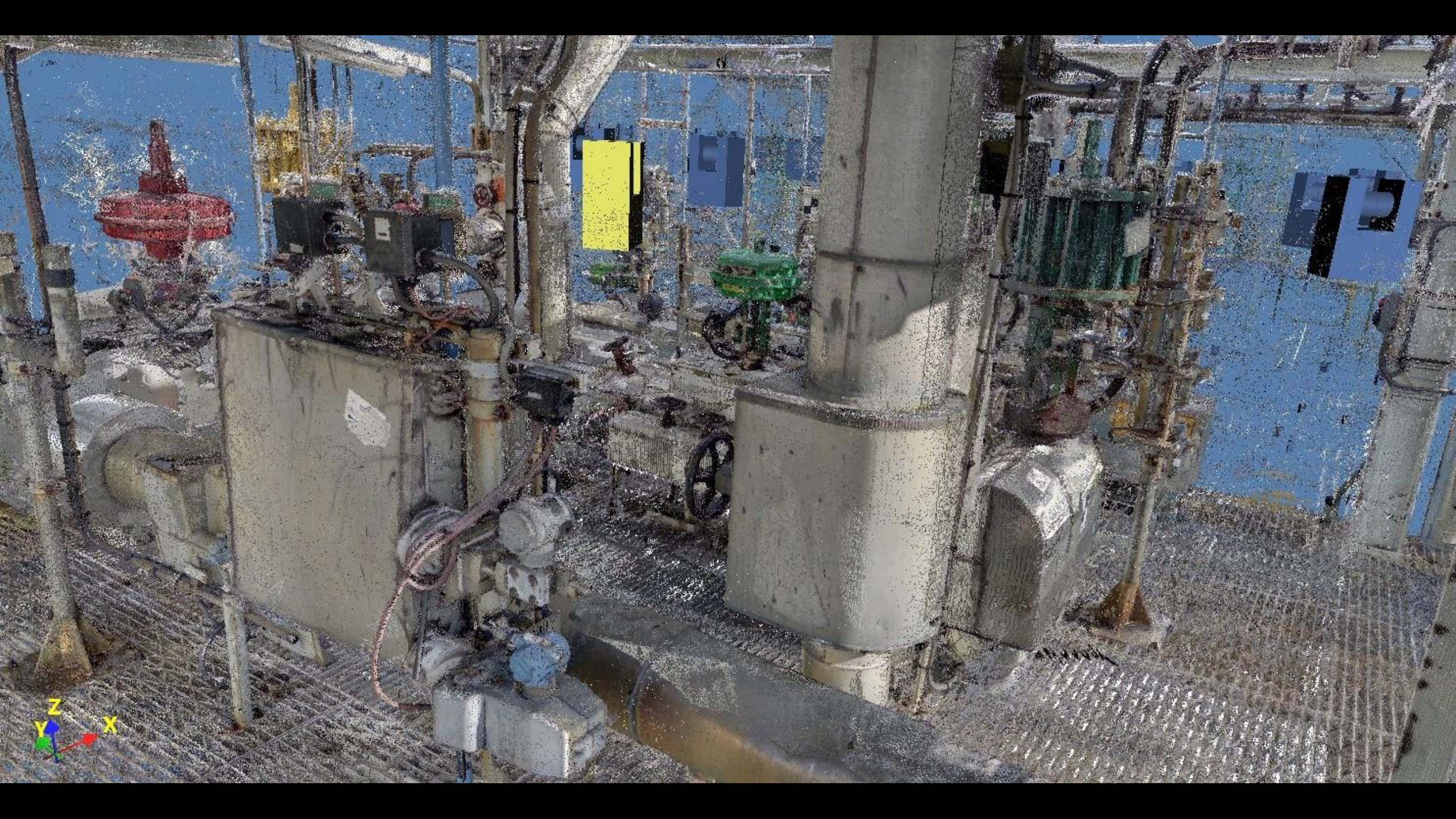

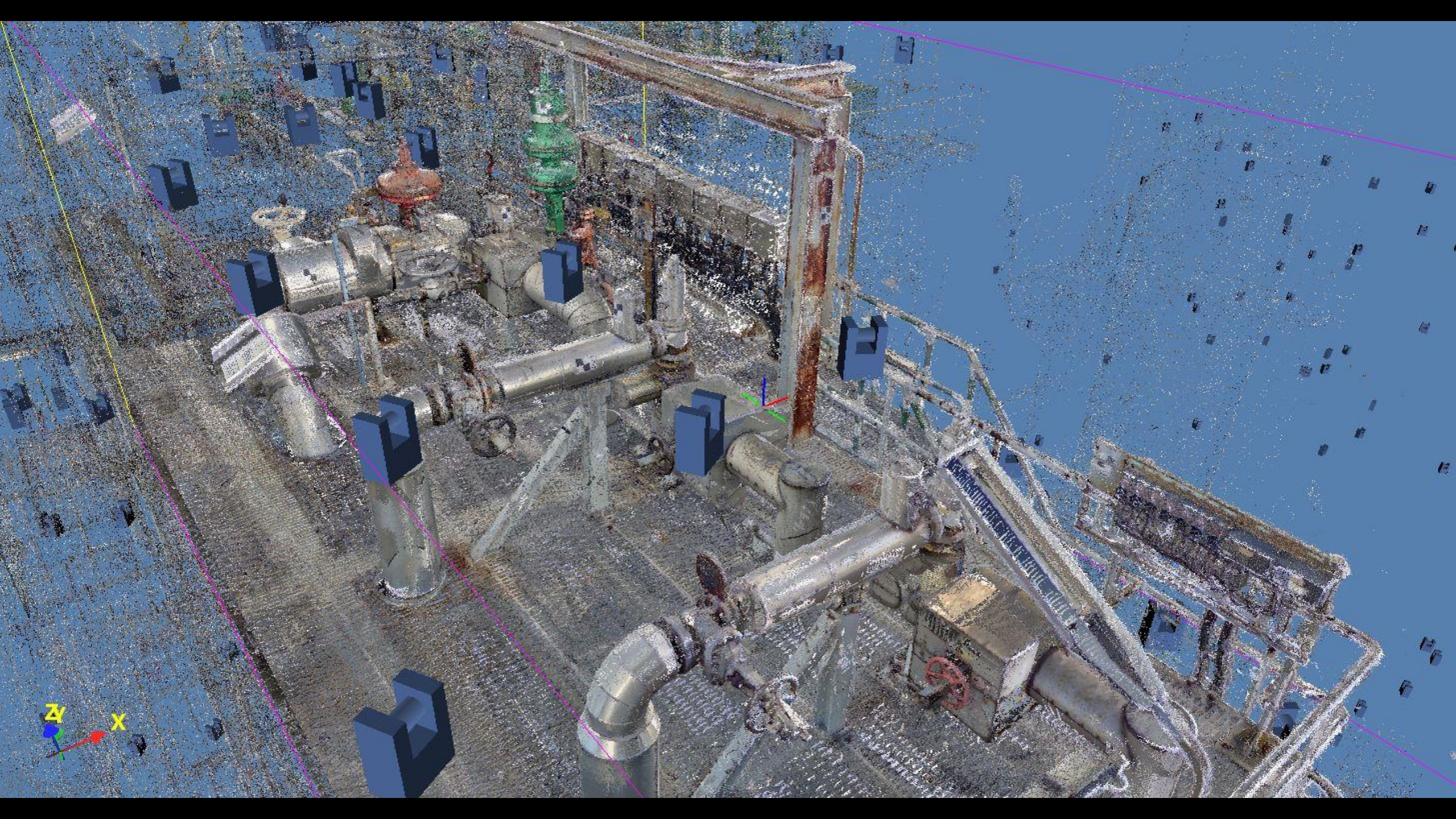

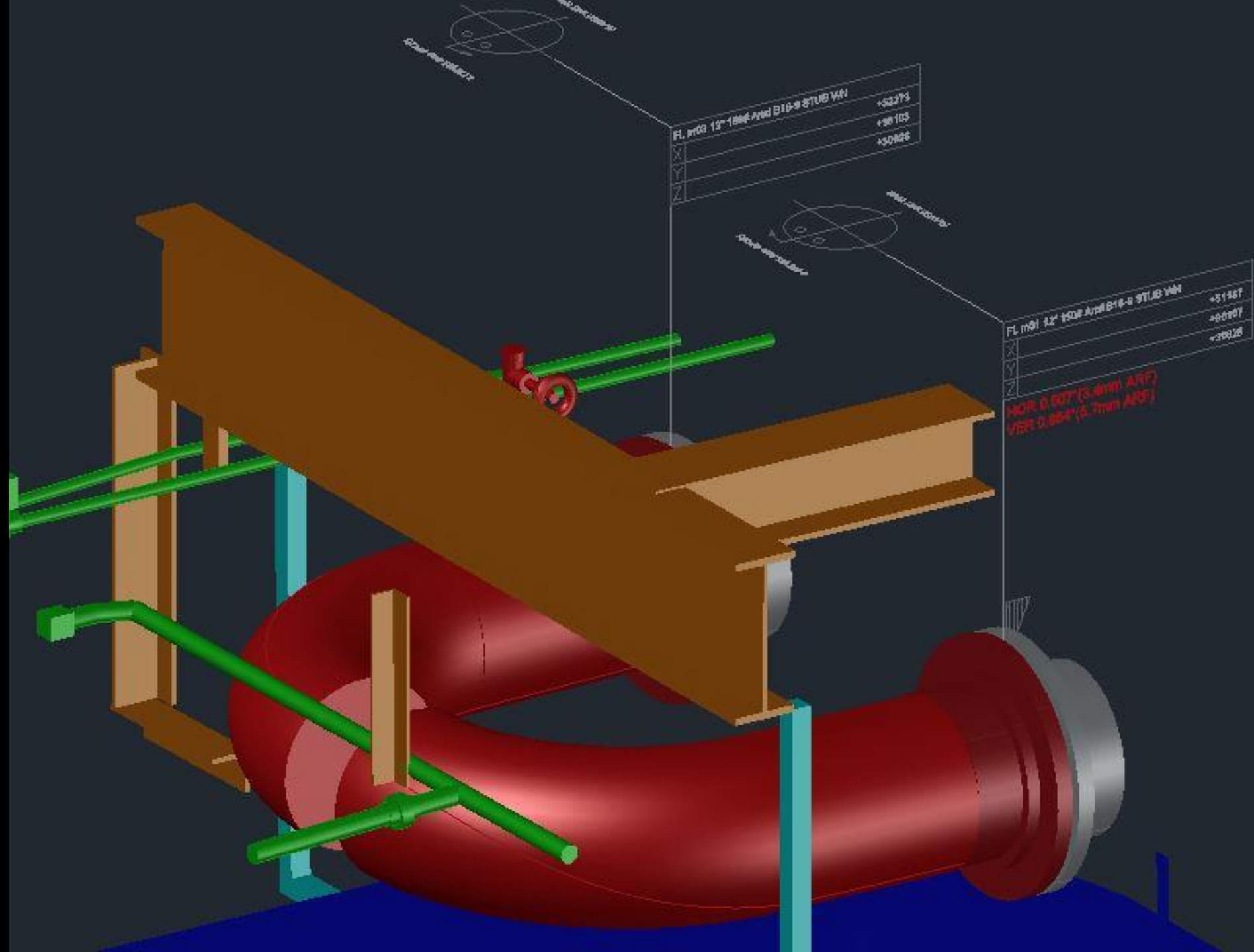



2.450 m



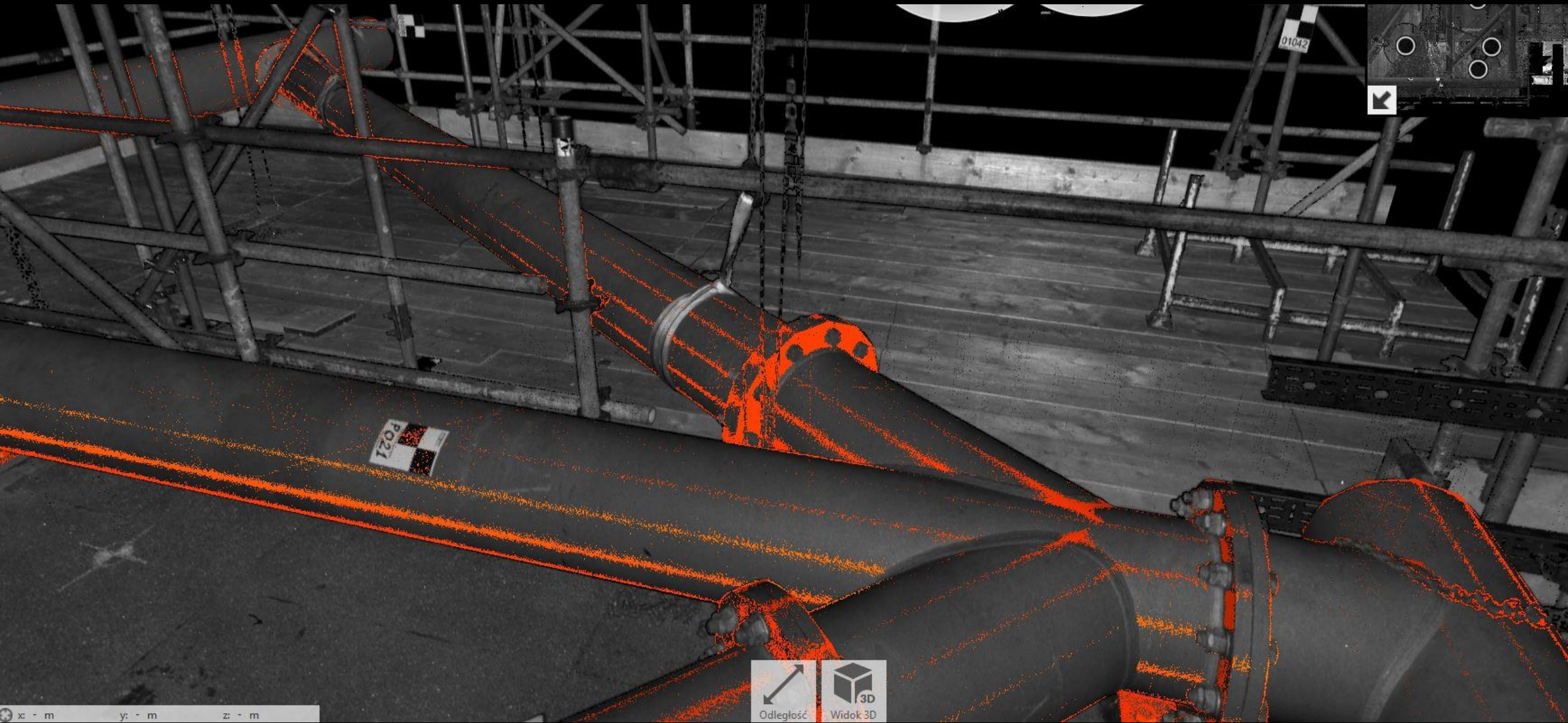

x - m y - m z - m

Odległość Widok 3D

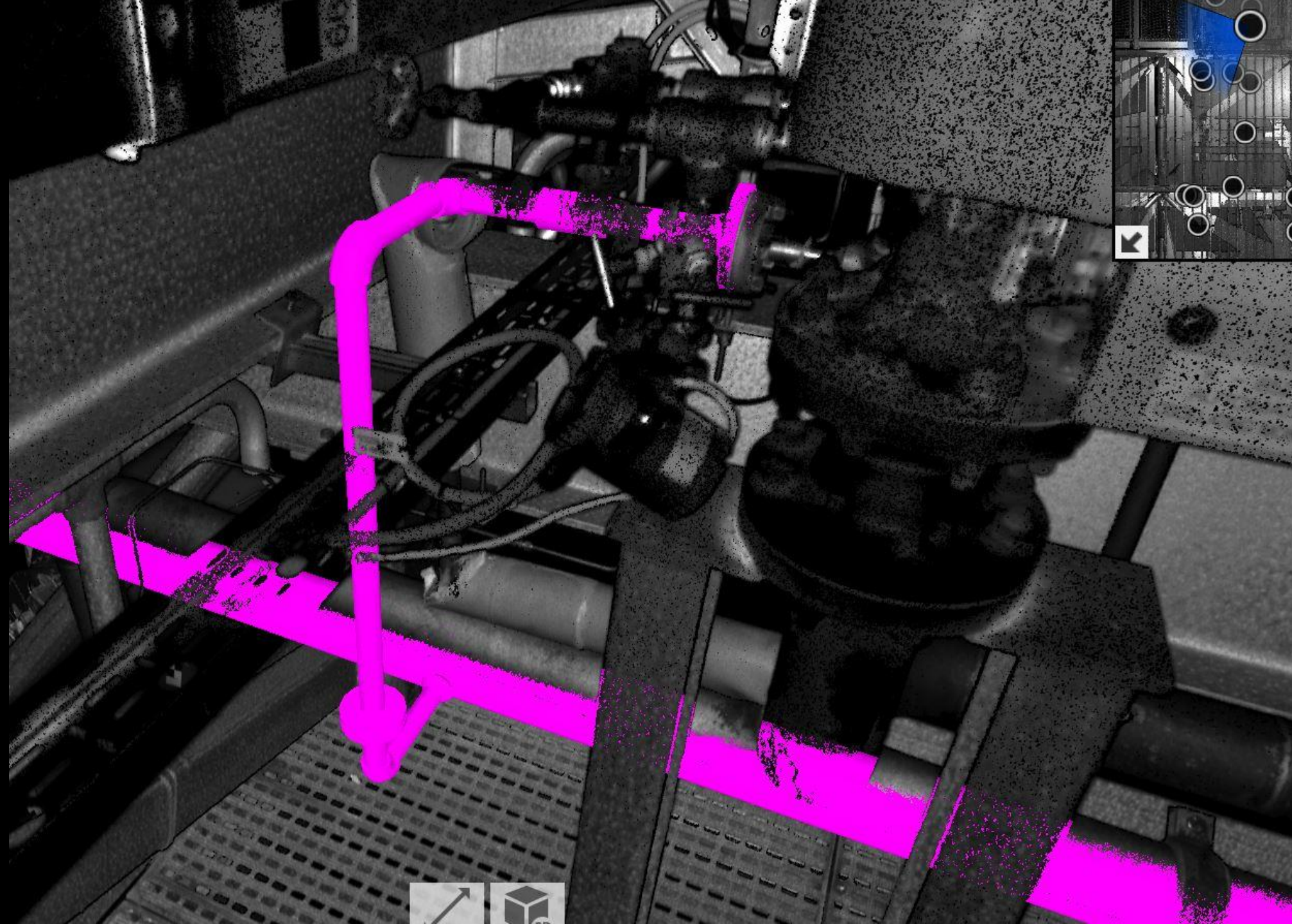

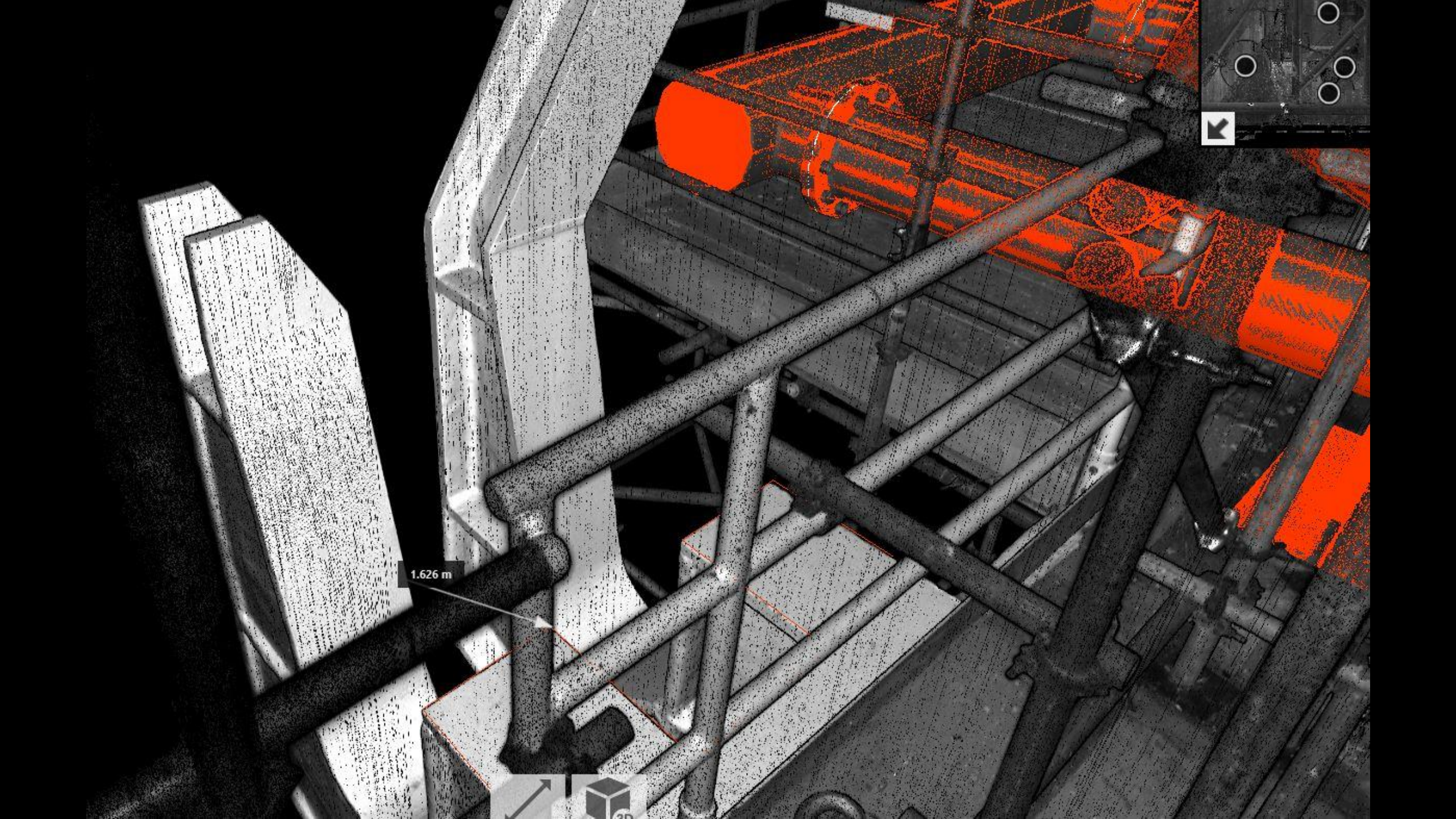

1.626 m



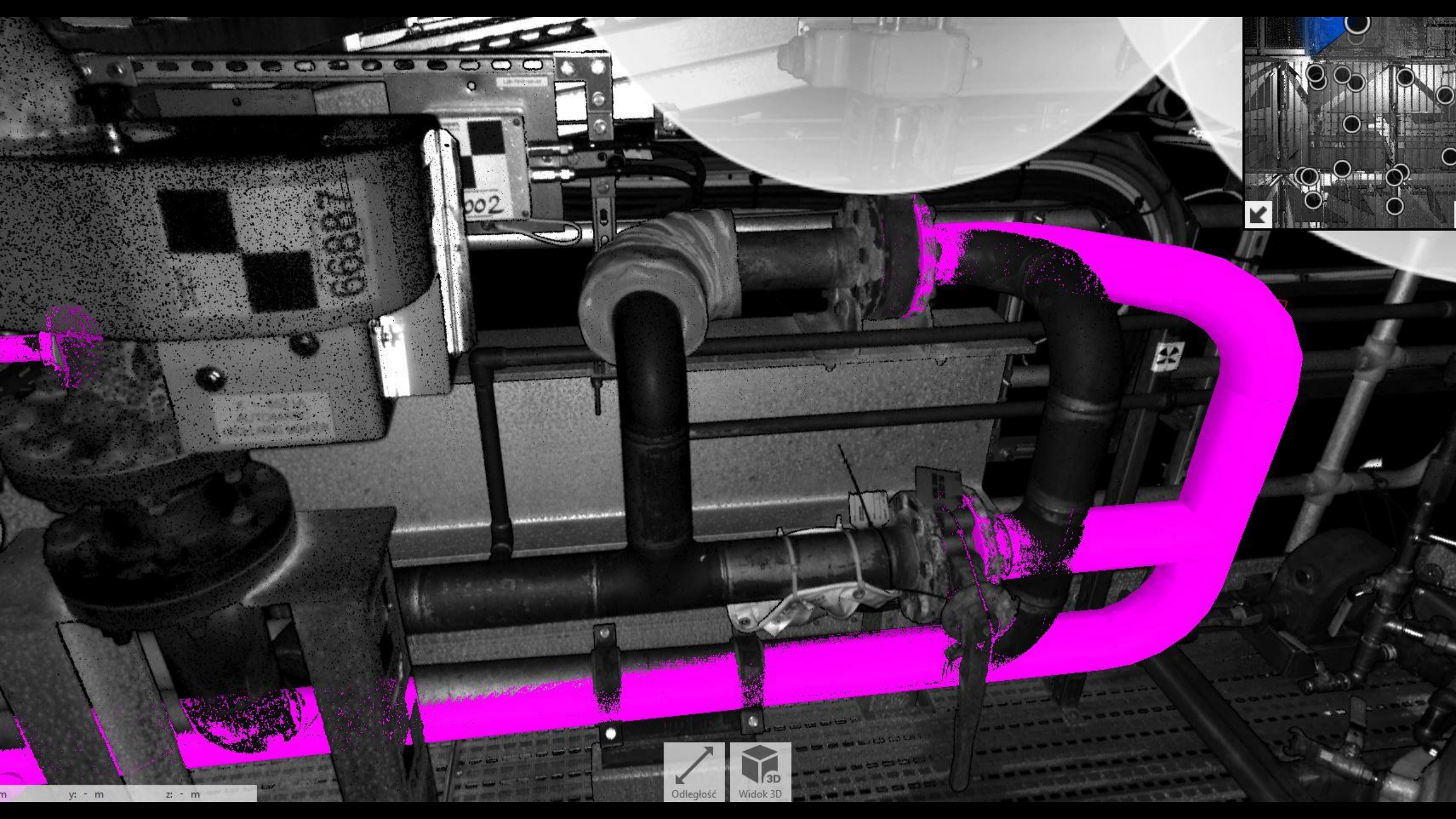

K

y: - m z: - m

Odległość

Widok 3D

ASUUI Labw

Type a keyword or phrase

Sign In

Branches Fittings Valves Pipe Misc Window File Edit View Insert Format Tools Dra

STANDARD

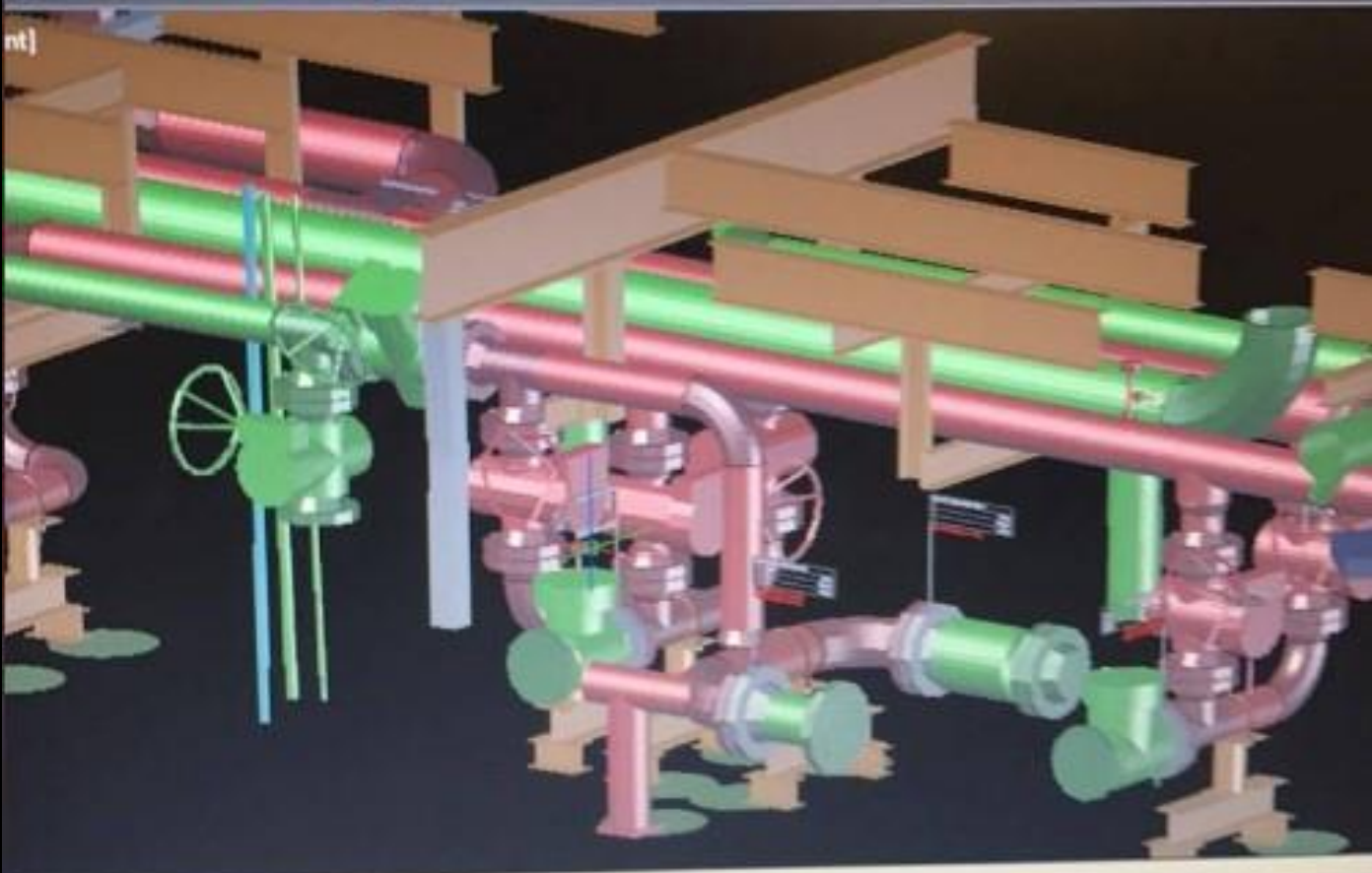

Layout1 /

or ENTER to exit, or right-click to display shortcut-menu.

Reminders: Borrowed
The borrowed license expires on 11/11/2011.
If you want to return your license, click here.

MODEL 3